

CNC Universal Milling Machines /
CNC Universal Machining Centres
DMU / DMC
monoBLOCK® series

DMG

02 | 03 Applications and Parts

04 | 11 Machine, Technology and DMU 40 / 60 / 80 / 100 monoBLOCK® Options

12 | 15 Machine and Technology DMC 60 T monoBLOCK® / Automation

16 | 17 Controls

18 | 20 Performance Diagrams and Floor Plans

21 | 22 Technical Data and Options



DMU / DMC monoBLOCK® series:
The best solution for simple to complex cubical workpieces and for single part to small series production.

DMU / DMC monoBLOCK® series – Universal Milling Machine for 3 to 5-axis simultaneous operations.

As metal removal production for single part and small series manufacturing moves towards large series production, there is a need for a machine design that covers the entire range. The DMU / DMC monoBLOCK® series meets those requirements with its ability to handle various applications and its expandable, compact design, all at an unbeatable price.

This series represents the latest concept in Universal Milling Machines with its monoBLOCK® design. Its ability and range of applications for cubic workpieces for single to serial production is unrivaled in this machine class. The DMU / DMC monoBLOCK® series provides state-of-the-art and efficient machining for classic universal operations, tool and mould making with slanted tools, complete machining with 5-sided / 5-axis machining, or wherever negative angles are required.

11| Mould insert for cover / Automotive industry 12| Mould insert / Automotive industry 13| Reflector mould / Automotive industry 14| Housing for underwater camera 15| Mould for cellular phone 16| Mould for mud guard / Bicycle industry 17| Bottle mould / Synthetics industry

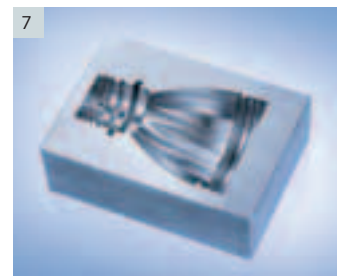
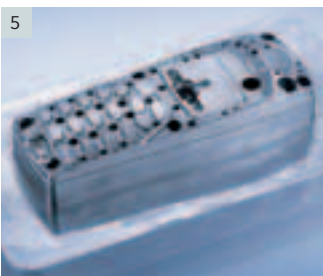
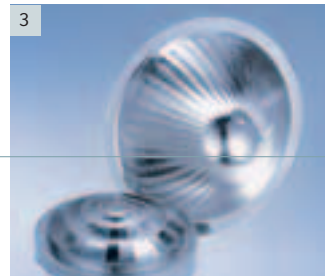
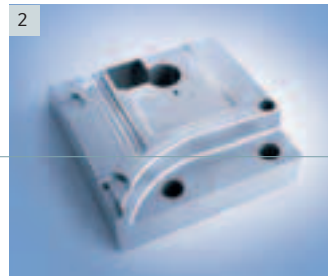

DMU 40 / 60 / 80 / 100 monoBLOCK® – Highly dynamic, for the shortest cycle times at the highest quality.

Unlimited performance with maximum flexibility – the new DMU monoBLOCK® machines are in a class by themselves: They have five axes in the standard version*, or they can be expanded in a class of their own in a modular fashion with machine-specific spindle options ranging from 10,000 rpm to 42,000 rpm. They have a fast and dynamic NC-swivel milling head, functioning as a B-axis* with a large swivel range even for negative angles up to 30°, as well as a fast NC rotary table*. These innovative machines open up a wide range of efficient universal machining applications, all the way into the high-speed sector, with easy access and maximum ease-of-use.

The most noticeable feature of the ergonomic machine design is the revolving door that gives you access to 100% of the work area with a single twist of the hand. These machines require minimum floor space, which is an essential advantage of the compact monoBLOCK® that has a footprint (in the DMU 40) of only 4 m².

* Standard for the DMU 40

DMU 40 / 60 / 80 / 100 monoBLOCK®:

Three to five axes, the highest dynamics, a new swivelmilling head with a B-axis for negative angles up to 30°, and a unique selection of various spindles. The modular monoBLOCK® design ensures the necessary rigidity and offers the best ergonomics, with a large viewing panel and a wide-opening revolving door, for simple loading and direct access to the work table.



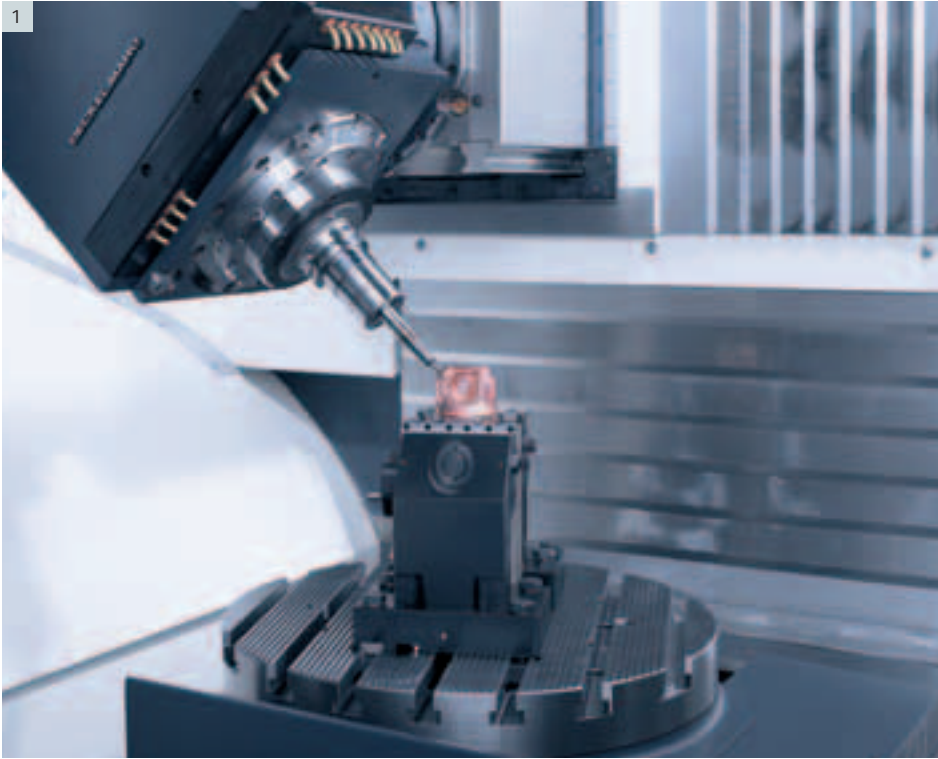

I1| Large work area with the integrated NC rotary table and the NC-controlled milling head (optional, standard for the DMU 40)

I2| Milling head as a controlled B-axis for applications requiring negative angles





DMU 40 / 60 / 80 / 100 monoBLOCK® Highlights

- _ **New design:** Optimal access and greater visibility into the work area as well as the DMG ERGOline® Control with a 19" screen and DECKEL MAHO MillPlus V600 or Heidenhain iTNC 530
- _ **Compact design: e.g. only 4 m² machine footprint** (DMU 40), machine height: e.g. 2,110 mm (DMU 40) or 2,468 mm (DMU 80)
- _ **Excellent dynamics** in the standard version due to **0.7 g acceleration, rapid traverse and feed up to 30 rpm** as well as fast rotary axes for use in advanced mould making
- _ **In the standard version:** Integrated scraper band conveyor and 250 l-coolant tank, geometric temperature compensation, completely enclosed safety cabin, energy supply integrated into the milling head, trailing cable installation integrated into the base (no chip build-up, no collisions), CollisionMonitoring in the 5-axis version and iTNC 530, feed spindle, max. load up to 1,100 kg, with a fixed table and 800 kg for 5-axis machining*
- _ **DMU 40: 5-axis simultaneous milling in the standard version** – unique in this class, easy access to 5-axis machining, due to **state-of-the-art control technology**, even for complex workpieces with the most demanding requirements (medical technology, tool manufacturing, tool and mould making, aerospace)
- _ **DMU 60 / 80 / 100: Multi-purpose machines** with three axes in the standard version, with optional 3+2, 4 or 5 axes, ideal for 5-sided machining and simultaneous 5-axis milling and a chain magazine with 60 tool pockets
- _ **HSC motor spindles*** (optional) with 24,000 rpm (HSK-A 63) with 26 kW and 85 Nm, 30,000 rpm as well as 42,000 rpm (HSK-E 50) with 13 kW and 8.3 Nm (40% DC), motor spindle with 10,000 rpm with 30 kW and 288 Nm torque for high volume metal removal in the steel sector (optional, not for the DMU 40 / 60)
- _ **Optional: Production package** with **600 l-coolant tank and internal coolant supply (40 bar)**, **3D quickset:** Option for monitoring and adjusting of axis-accuracy in the work area, **ATC** (Application Tuning Cycle): Option for easy tuning of the linear feed drives at the press of a button, for the shortest machining times with improved quality

* According to machine type

**DMU 40 / 60 / 80 / 100 monoBLOCK®****Dynamics Highlights:**

Up to 0.8 g accelerations, fast linear and rotary axes, rapid traverse and linear feed up to 30 rpm, as well as rotary up to 60 rpm.

Stability with top performance.

The innovative monoBLOCK® design of the DMU series has numerous benefits that include greater sturdiness, more speed, accuracy, better surface quality and lower space requirements. The design makes it possible for longitudinal and lateral motions to be performed by the milling head, while only the vertical motions need to be traversed by the table. This leads to greater dynamics and ensures optimal traction in the Z-axis guideway. In addition, machining height does not affect machining quality. The dynamics of this machine series is reflected in rapid traverse speeds of 30 rpm up to 60 rpm in the rotary axes. The modular monoBLOCK® design ensures the necessary sturdiness and also provides optimal ergonomics and easy handling. The funnel design of the machine bed is another new feature that ensures the best return of chips and coolant.

The extensive standard equipment includes the liquid-cooled motor spindle, digital drives with direct measuring systems, roller guideways free from float, 3-point support for fast setup, a scraper-belt chip conveyor, geometric temperature compensation, the latest open CNC controls and 5-axis simultaneous milling capabilities for the DMU 40.



Maximum precision: Digital drives, direct measuring systems, electronic temperature compensation and a sturdy monoBLOCK® design for high feed power and maximum precision.

Greatest stability: The linear guideways in the Z-axis with 430 / 530 / 600 / 600 mm (DMU 40 / 60 / 80 / 100) ensure stability for absolute precision.

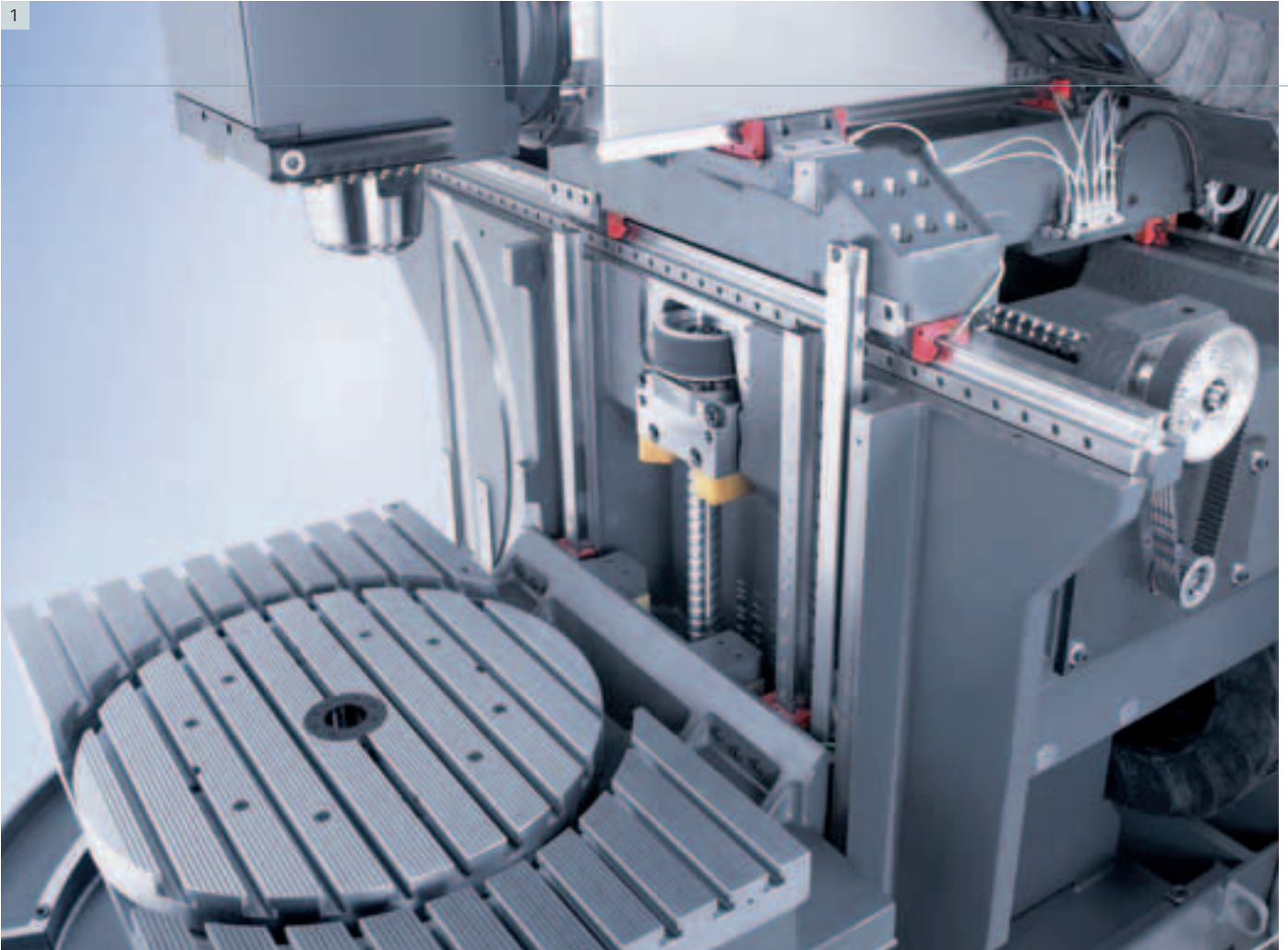

- I11 Digital drives and direct measuring systems
- I21 Integrated scraper-belt chip conveyor
- I31 Optimised tool magazine for 16, 24 or 32 tools
- I41 Tool chain-magazine with 60 tool pockets (optional)

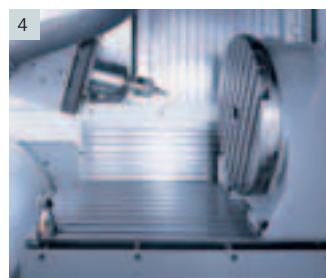
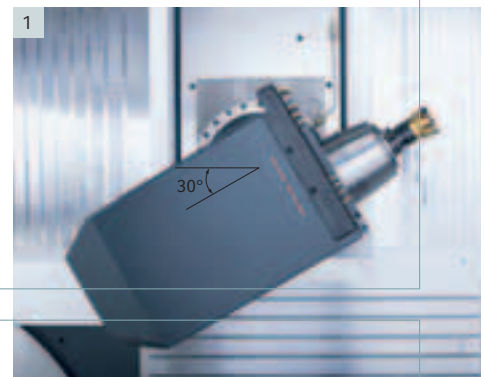
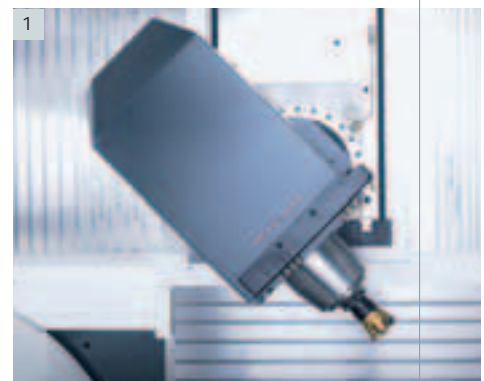
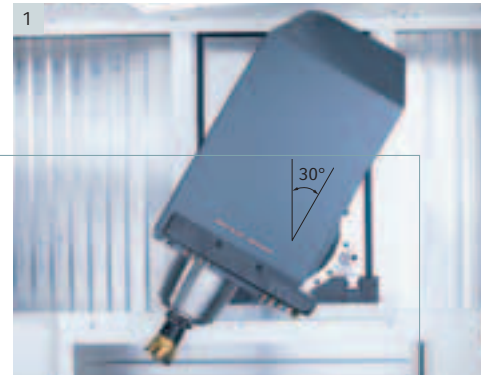

- |1| Milling head as an NC-controlled B-axis with up to a 150° swivel range
- |2| Internal coolant supply
- |3| NC rotary table integrated into the fixed table
- |4| NC attachment table, mounted vertically

Simple expansion options and unique spindle diversity for even greater flexibility.

Motor spindles with 12,000, 18,000, 24,000 rpm and HSK-A63, as well as 30,000 and 42,000 rpm with HSK-E50, available for all models, leading to maximum milling performance and best surface quality in the HSC sector. A torque spindle for the DMU 80 / 100 monoBLOCK® with 286 Nm and 10,000 rpm, combined with the optionally available production package (coolant supply through the spindle centre, rotating viewing glass, work area flusher, etc.) and the extremely stable monoBLOCK® design, lead to excellent chip-removal performance even in high-volume steel machining. Electronic hand wheel, calliper, and tool measurement in the work area, and an oil mist separator, etc. offer the right solution for every requirement.

The more specific your machining needs in the 5-axis sector, the more you will come to appreciate the five axes in the standard version on the DMU 40 monoBLOCK®, or the expansion options of the DMU 60 / 80 / 100 monoBLOCK®. The CNC controlled B-axis* with a swivel range up to 150° allows complex 5-sided or 5-axis machining when combined with the NC rotary table*, the integrated NC rotary table, the NC attachment table or the NC workpiece unit. The NC attachment table is available for all three models, and can even be mounted both horizontally and vertically on the DMU 60 and 80 monoBLOCK®.

* Standard for the DMU 40



15| NC workpiece unit with a rapid traverse of 22 rpm,
or as high-performance unit

16| Tool measurement via a laser beam (Fa. Blum)

17| Heidenhain TS 649 infrared calliper



- I1| Large work area with a 150° B-axis
- I2| Standard-equipped with a fast rotary pallet changer
- I3| Machining angles up to -30°
- I4| Tool changer with a double gripper

DMC 60 T monoBLOCK®:

This 5-axis Compact Universal Machining Centre offers the most efficient use of space, excellent rigidity, ergonomics, a small footprint and a rotary pallet changer arranged at a 45° angle. The standard-equipped production package with 40 bar. internal cooling unit, 900 litres coolant tank, paper band filter, scraper-belt chip conveyor and Rotoclear view window, provide the highest productivity.

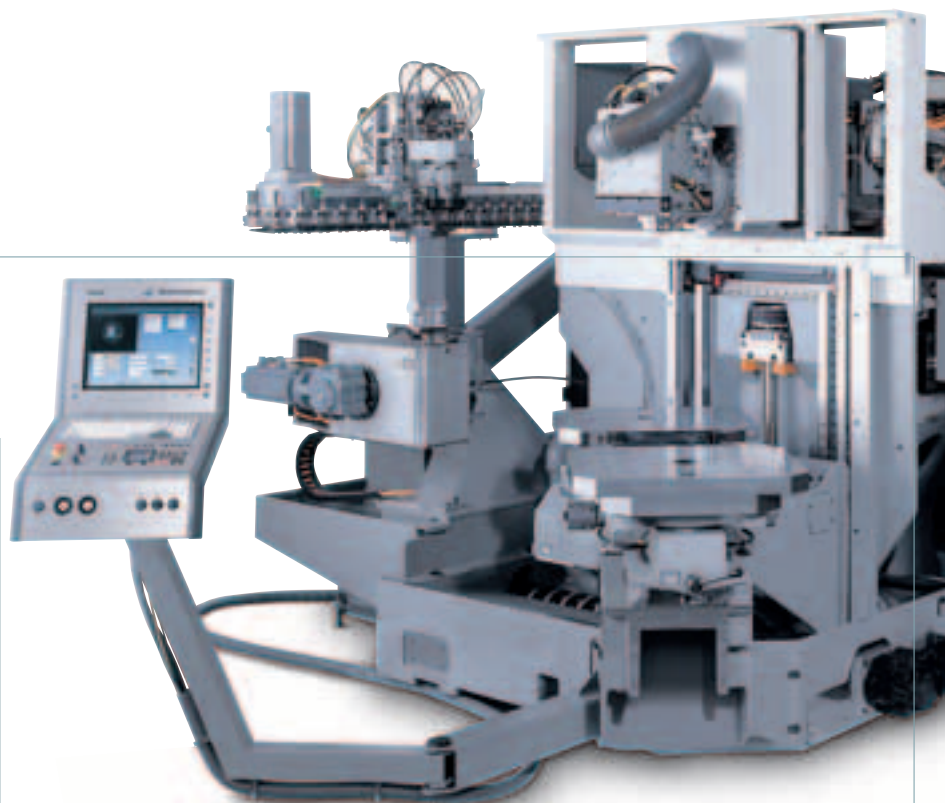

DMC 60 T monoBLOCK® – All-inclusive 5-axis compact Universal Machining Centre!

This compact Universal Machining Centre comes standard-equipped with five axes, making it unique in its class. This successful machining centre is based on the monoBLOCK® design and is paired with a fast and compact pallet changer. When combined with an optimised work area and excellent control options, the DMC 60 T can deliver productive solutions even for the most challenging operations. In addition, the production package is already standard so that all machining requirements are met.

The outstanding features of this machining centre that have been designed specifically for universal productivity are excellent dynamics in all five axes, chip-to-chip times of less than 6 seconds, a chain magazine for up to 180 tools with a fast double gripper and a milling head with a 150° swivel range. These features allow 5-sided / 5-axis machining and set new standards in the universal compact class.



Highlights

- _ **5-axis Compact Machining Centre** is standard-equipped with a fast rotary pallet changer (two pallets)
- _ **RS 3 rotary magazine** (optional) – with three additional pallets
- _ **Rapid traverse and feed at 50 rpm**, acceleration of 6 m/s² in the X and Y-axes and 5 m/s² in the Z-axis
- _ **Highest dynamics also in the milling head** (switch from horizontal to vertical in 0.8 seconds), 150° swivel range of the B-axis, with angles up to negative 30°
- _ **NC rotary table with a rapid traverse of 30 rpm** in the standard version
- _ **Fast tool exchange with a double gripper** (chip-to-chip time ≤ 5.5 seconds)
- _ Optimal chip disposal with the **standard-equipped production package** (900 l, 40 bar internal coolant supply, scraper-belt conveyor, paper band filter, etc.)
- _ **ATC software** and **3D quickSET** (optional)

Automation solutions for maximum productivity.

In the configuration for entry-level automation with the RS3 rotary magazine, the DMC 60 T monoBLOCK® has extremely low space requirements and excellent access to the setup and work area. The key factors for the excellent sales figures and the impressive list of references for this basic automation solution are: good standard features, a high degree of universality and an attractive price. The automated DMC 60 T RS3 is used predominantly in medical technology and the aerospace industries, by component manufacturers (production, hydraulic, pumps, compressors), or in job order production of all types of workpieces.

Highlights

- _ DMC 60 T RS3 monoBLOCK® with a fast rotary pallet changer, 5-axis RS3 rotary magazine simultaneous milling and production package with pallets in the system (optional)
- _ Automation solution with a robot and automatically opening work area door
- _ Simple pallet handling for flexible production up to max. 200 kg and work piece handling up to max. 25 kg
- _ Perfect ergonomics and operation, both in automatic and manual mode
- _ Preparation of the machine available with automation interface or a turnkey automation solution

DMC 60 T monoBLOCK® with an RS3 rotary magazine: Three additional pallets – for a total of five pallets in the system.





I1+2I Automatic pallet handling and a pallet magazine with 20 pockets



Automation solutions for the monoBLOCK® series:
e.g. DMU 40 monoBLOCK® with an automatic loading
and unloading system with a 6-axis robot, pallet-hand-
ling system with a pallet weight of 50 kg and 20 pockets.



1| DMG ERGOline® control with DMG SOFTkeys® –
customisable hotkeys for frequently used screen content or regularly used operational sequences

2| DMG SMARTkey® –
the electronic access control for the personalised authorisation of the operator with user-specific access privileges for the control and machine.



3| CollisionMonitoring* –
on Heidenhain iTNC 530:
_ Optimum protection of the machine from collision
_ Dynamic monitoring and optimal usage of the work area
_ Relief of strain for the operator

* For all 5-axis machines with Heidenhain iTNC 530 as standard



ATC: Tuning of the feed drives at the press of a button

Three settings (surface, speed, precision) are available from anywhere within the workpiece programme.

Your benefit: Minimum machining time combined with maximum quality (programming also available in relation to workpiece weight).

3D quickSET: For monitoring and adjusting axis accuracy in the work area

_ Correction function to adjust precision of the delivery status
_ Easy operator handling

Siemens 840D powerline*

_ ShopMill with Windows XP™
_ 3D-simulation
_ Fast network access
_ Job processing directly from the hard drive
_ Quick editing of large programmes
_ Simple, visually-supported setup
_ Extensive tool management

DMG ERGOline® Control with a 19" screen and 3D-workpiece simulation.

The most significant highlight of the new machine design is the DMG ERGOline® Control with a 19" screen. The larger screen ensures better readability and allows the integration of additional DMG SMARTkey® and additional status information, which leads to more efficient overall operation. The screen and the operator panel can also be tilted and adjust for comfort. This is also true for the optional seat and mousepad. The key switch is replaced by an intelligent DMG SMARTkey® with a chip, which offers complete ease-of-use, with features ranging from retrievable machine operating modes to personalised user access.

The operator has access to state-of-the-art software, such as the Heidenhain iTNC 530 or the new DECKEL MAHO MillPlus iT V600. The DMC 60 T offers the Siemens 840D powerline as an additional alternative.

All CNC control options are seamlessly integrated into the performance range of the DMU / DMC monoBLOCK® series, with high storage capacities and extremely fast processors.

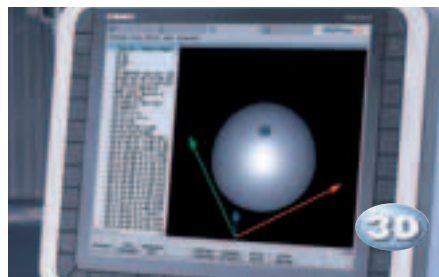
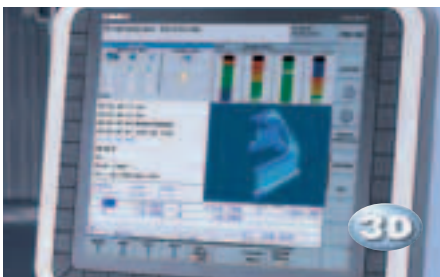

Heidenhain iTNC 530

- _ Workshop or DIN/ISO programming
- _ 3D-workpiece simulation
- _ Graphic programming
- _ Coordinate transformation
- _ Fast programme generation through graphic programming
- _ Ease-of-use with a wide range of available cycles
- _ Standard-equipped with CollisionMonitoring in the 5-axis version

Heidenhain MillPlus iT

- _ DMG 3D-software MillPlus
- _ State-of-the-art software interfaces
- _ Adjustable lurch control
- _ 3D-workpiece simulation
- _ Ergonomic menu design
- _ Excellent flexibility during data access
- _ Integrated safety technology

DECKEL MAHO MillPlus iT V600

- _ New, pioneering functions with the "look and feel" of the familiar Heidenhain MillPlus iT
- _ Intuitive operation
- _ Clearly laid-out programme structure
- _ Fast loading and editing of memory intensive programmes
- _ High-level language (HLL) elements
- _ USB functionality
- _ New mould making functions

Torque / Performance Diagrams

DMU 40 / 60 / 80 / 100

Standard equipped 12,000 rpm

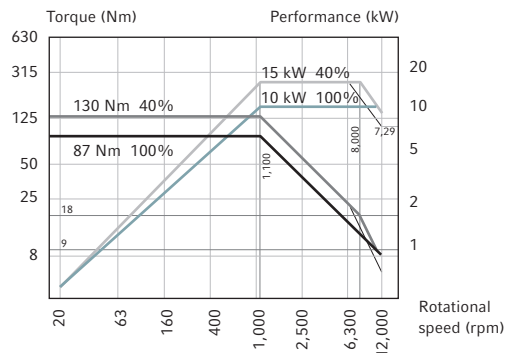

DMC 60 T

Standard equipped 12,000 rpm

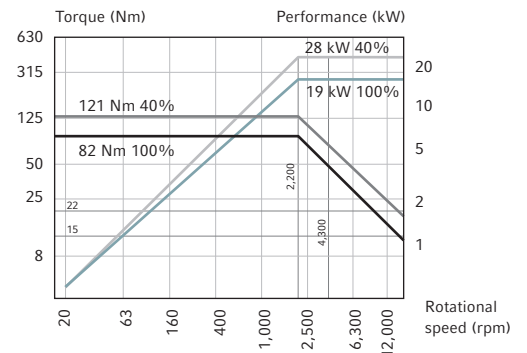

DMU 40 / 60 / 80 / 100, DMC 60 T

Optional 18,000 rpm

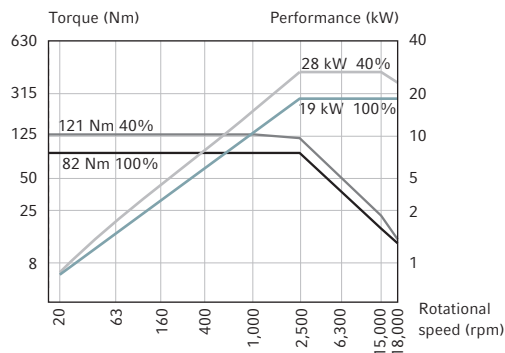

DMU 40 / 60 / 80 / 100, DMC 60 T

Optional 24,000 rpm

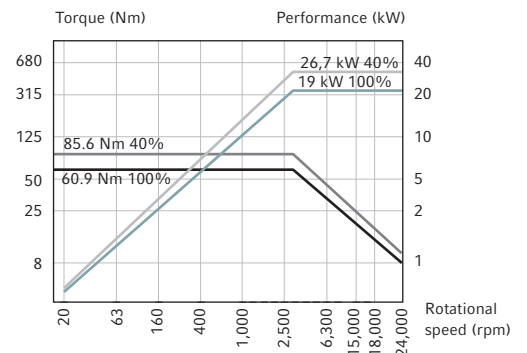

DMU 80 / 100

Optional 10,000 rpm

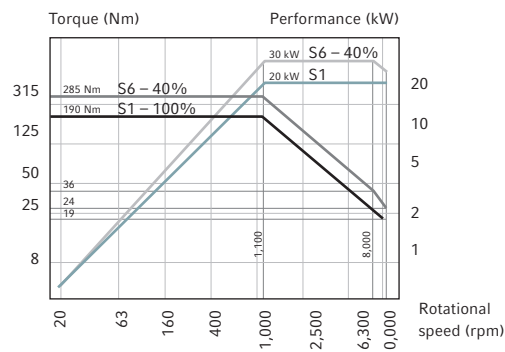

DMU 40 / 60 / 80 / 100

Optional 30,000 rpm

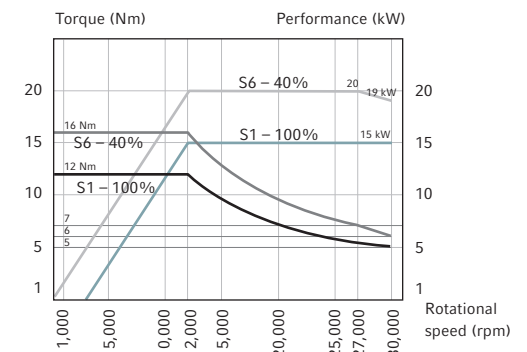

Torque / Performance Diagrams

DMU 40 / 60 / 80 / 100

Optional 42,000 rpm

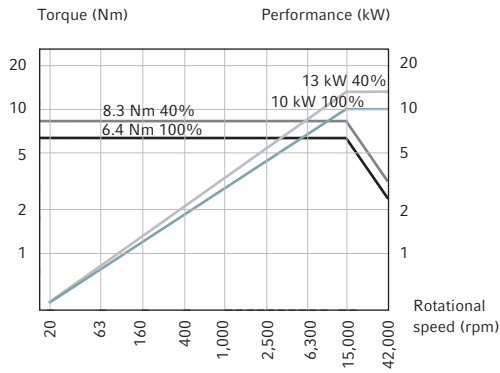

Floor Plans

DMU 40 monoBLOCK®

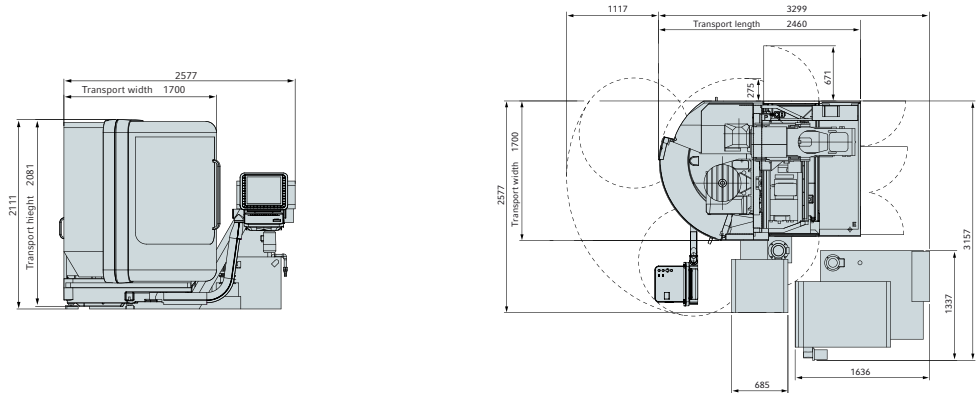

DMU 60 monoBLOCK®

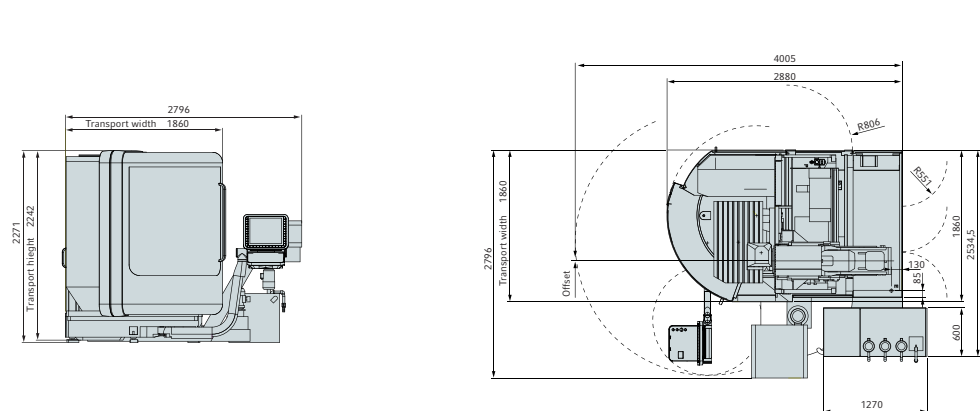

Floor Plans

DMU 80 monoBLOCK®

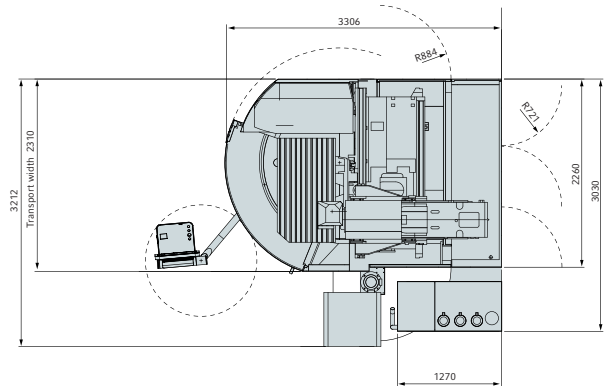
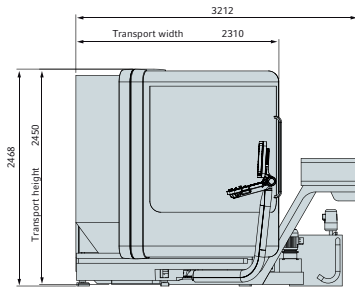

DMU 100 monoBLOCK®

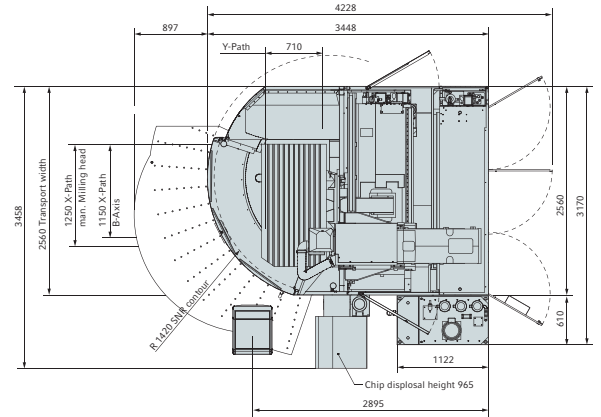
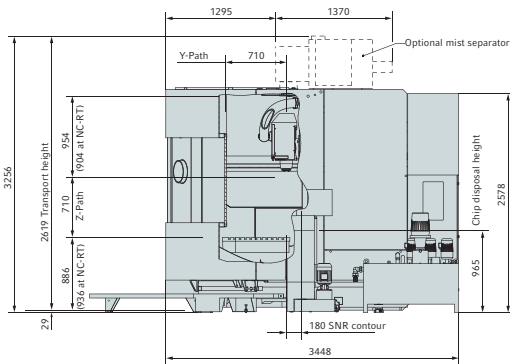

DMC 60 T monoBLOCK®

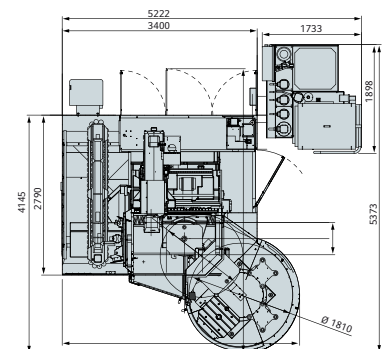
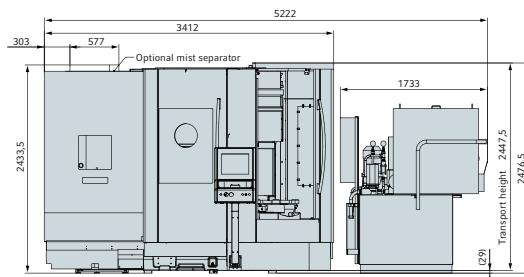

Technical Data

		DMC 60 T	DMU 40	DMU 60	DMU 80 / 100
Work area					
X / Y / Z-axis	mm	780 / 560 / 560	450 / 400 / 480	730 (630*) / 560 / 560	980 (880*) / 630 / 630 1,250 (1,150*) / 710 / 710
Max. rapid traverse and feed rate	rpm	50	30	30	30
Machine weight	kg	8,500	4,500	6,300	9,100 / 9,900
3D CNC control		•	•	•	•
Tool changer					
Tool fitting		SK40	SK40	SK40	SK40
Tool magazine	Type	Chain	Plate magazine	Plate magazine	Plate magazine
Number of magazine pockets		30 (60 / 120 / 180)	16	24	32
Chip-to-chip time	sec.	5.5	9	9	10 / 11
Main drive motor spindle					
Performance (40 / 100% DC)	kW	28 / 19	15 / 10	15 / 10	15 / 10
Max. torque (40 / 100% DC)	Nm	121 / 82	130 / 87	130 / 87	130 / 87
Max. spindle speed	rpm	12,000	12,000	12,000	12,000
Milling heads					
Manual swivel milling head		–	–	•	•
Swivel range (0 = vert. / -90 = hor.)	Degrees	–	–	+12 / -91	+12 / -91
NC-controlled swivel milling head (B-axis)		•	•	o	o
Swivel range (0 = vert. / -90 = hor.)	Degrees	+30 / -120	+30 / -95	+30 / -120	+30 / -120
Swivel time	sec.	1.5	1.5	1.5	1.5
Rapid traverse	rpm	35	35	35	35
Tables					
Fixed table		–	–	•	•
Dimensions	mm	–	–	1,000 x 600	1,250 x 700 / 1,500 x 800
Max. load	kg	–	–	700	900 / 1,100
NC rotary table integrated into the fixed table		–	–	o	o
Dimensions of rotary table	mm	–	–	ø 600	ø 700 / 800
Dimensions of fixed table		–	–	1,000 x 600	1,250 x 700 / 1,500 x 800
Max. load	kg	–	–	500	650 / 800
Max. rapid traverse and feed rate	rpm	–	–	40	30
NC rotary table (C-axis)		–	•	–	–
NC rotary table (C-axis) with a pallet changer		•	–	–	–
Dimensions table / pallet	mm	500 x 630	ø 450	–	–
Max. load	kg	400	250	–	–
Max. rapid traverse and feed rate	rpm	30	60	–	–
Pallet exchange time	sec.	10	–	–	–
Rotary pallet magazine RS3 incl. 3 pallets		o	–	–	–
NC attachment table		–	–	o	o
Dimensions	mm	–	–	ø 560	ø 700 / 800 x 630
Max. load	kg	–	–	400	600 / 500
Max. rapid traverse and feed rate	rpm	–	–	16	16
Assembly		–	–	vert. + hor.	vert. + hor. / vert.
NC workpiece unit with a tailstock		–	–	o	o
Swing	mm	–	–	160	220
Max. rapid traverse and feed rate	rpm	–	–	22	22
NC workpiece unit DECKEL MAHO High Performance		–	–	o	o
Performance	mm	–	–	160	160
Max. rapid traverse and feed rate	rpm	–	–	80	80

Options

		DMC 60 T	DMU 40	DMU 60	DMU 80/100
Tool changer chain magazine					
Number of tool pockets	Pockets	60 / 120 / 180	–	60	60
Integrated motor spindle 10,000 rpm					
Performance (40/100% DC)	kW	–	–	30/20	30/20
Max. torque (40/100% DC)	Nm	–	–	285/190	285/190
Tool fitting	DIN	–	–	SK40	SK40
Integrated motor spindle 18,000 rpm					
Performance (40/100% DC)	kW	28/19	28/19	28/19	28/19
Max. torque (40/100% DC)	Nm	121/82	121/82	121/82	121/82
Tool fitting	DIN	SK40	SK40	SK40	SK40
Integrated motor spindle 24,000 rpm					
Performance (40/100% DC)	kW	26/19	26/19	26/19	26/19
Max. torque (40/100% DC)	Nm	85/60	85/60	85/60	85/60
Tool fitting	DIN	HSK-A63	HSK-A63	HSK-A63	HSK-A63
Integrated motor spindle 30,000 rpm					
Performance (100% DC)	kW	–	15	15	15
Max. torque (100% DC)	Nm	–	11.9	11.9	11.9
Tool fitting	DIN	–	HSK-E50	HSK-E50	HSK-E50
Integrated motor spindle 42,000 rpm					
Performance (100% DC)	kW	–	10	10	10
Max. torque (100% DC)	Nm	–	6.4	6.4	6.4
Tool fitting	DIN	–	HSK-E50	HSK-E50	HSK-E50
Production package					
Internal coolant supply 20 or 40 bar through the spindle centre (Form AD), Rotoclear, chip flusher in the work area door		•	o	o	o
Coolant tank standard / optional	Litres	980 / 980	250 / 600	250 / 600	250 / 600
Scraper-belt chip conveyor		•	•	•	•
Tool fitting BT40, SK40, HSK-A63		o	o	o	o
Infrared calliper		o	o	o	o
Tool measurement in the work area		o	o	o	o
Chuck hydraulics for the fixed table / NC rotary table		o	o	o	o
Oil and emulsion mist separator		o	o	o	o
Shatterproof viewing glass		o	o	o	o
Minimum-quantity lubrication		o	o	o	o
Compressed air through the spindle centre		o	o	o	o
Electronic hand wheel		o	o	o	o
Operating mode 4		o	o	o	o
Rinsing pistol		o	o	o	o
2. Processor card for IT applications		o	o	o	o
3D quickSET Toolkit / Expansion package		o	o	o	o
ATC Application Tuning Cycle		o	o	o	o
3D CNC control DECKEL MAHO MillPlus iT V600		–	•	–	–
3D CNC control Heidenhain MillPlus iT		•	–	•	•
3D CNC control Heidenhain iTNC 530		•	•	•	•
3D CNC control Siemens 840D powerline		•	–	–	–

• = Standard, o = Optional, – = Not available, *** Available upon request



DMU 40 / 60 / 80 / 100 monoBLOCK® –
highest precision for workpiece
manufacturing in tool and mould
construction – with the new
DMU / DMC monoBLOCK® series.

Headquarters

DMG Vertriebs und Service GmbH
Gildemeisterstraße 60 · D-33689 Bielefeld
Tel.: +49 (0) 52 05 / 74 - 0
Fax: +49 (0) 52 05 / 74 - 40 40

DMG Europe Holding GmbH
Oberes Ried 11 · A-6833 Klaus
Tel.: +43 (0) 55 23 / 6 91 44 - 0
Fax: +43 (0) 55 23 / 6 91 44 - 100

Germany

DMG Berlin
Egeljuhlfstraße 42 a · D-13581 Berlin
Tel.: +49 (0) 30 / 35 19 06 - 0
Fax: +49 (0) 30 / 331 20 18
Service Turning: +49 (0) 3 71 / 815 01 - 26 to 27
Service Milling: +49 (0) 3 71 / 815 01 - 22 to 24
Service Fax: +49 (0) 3 71 / 815 01 - 10

DMG Chemnitz
Südstraße 1 · D-09221 Neukirchen
Tel.: +49 (0) 3 71 / 81 50 1 - 0
Fax: +49 (0) 3 71 / 81 50 1 - 11

DMG Bielefeld
Gildemeisterstraße 60 · D-33689 Bielefeld
Tel.: +49 (0) 52 05 / 74 - 22 33
Fax: +49 (0) 52 05 / 74 - 22 39
Service Tel.: +49 (0) 52 05 / 74 - 22 22
Service Fax: +49 (0) 52 05 / 74 - 22 19

DMG Frankfurt
Steinmühlstraße 12 d · D-61352 Bad Homburg
Tel.: +49 (0) 61 72 / 495 57 - 0
Fax: +49 (0) 61 72 / 495 57 - 30
Service Turning: +49 (0) 61 72 / 49 55 7 - 21
Service Milling: +49 (0) 61 72 / 49 55 7 - 20
and +49 (0) 61 72 / 49 55 7 - 27
Service Fax: +49 (0) 61 72 / 49 55 7 - 40

DMG Hilden
Im Hülsenfeld 23 · D-40721 Hilden
Tel.: +49 (0) 21 03 / 57 01 - 0
Fax: +49 (0) 21 03 / 57 01 - 40
Service Turning: +49 (0) 21 03 / 57 01 - 31
Fax: +49 (0) 21 03 / 57 01 - 39
Service Milling: +49 (0) 21 03 / 57 01 - 21
Fax: +49 (0) 21 03 / 57 01 - 44

DMG München
Lautitzer Straße 7 · D-82538 Geretsried
Tel.: +49 (0) 81 71 / 81 7 - 51 50
Fax: +49 (0) 81 71 / 81 7 - 51 59
Service Turning: +49 (0) 81 71 / 81 7 - 51 80
Service Milling: +49 (0) 81 71 / 81 7 - 51 70
Service Fax: +49 (0) 81 71 / 81 7 - 51 79

DMG Stuttgart
Riedwiesenstraße 19 · D-71229 Leonberg
Tel.: +49 (0) 71 52 / 90 90 - 0
Fax: +49 (0) 71 52 / 90 90 - 20 00
Service Turning: +49 (0) 71 52 / 90 90 - 12 10
Service Milling: +49 (0) 71 52 / 90 90 - 12 20
Service Fax: +49 (0) 71 52 / 90 90 - 22 08

GILDEMEISTER Italiens Deutschland
Riedwiesenstraße 19 · D-71229 Leonberg
Tel.: +49 (0) 71 52 / 90 90 - 11 51
Fax: +49 (0) 71 52 / 90 90 - 21 75
Service multi-spindle automatic lathes:
+49 (0) 71 52 / 90 90 - 12 36
Service long and short turning automatics:
+49 (0) 71 52 / 90 90 - 12 37

DMG Trainings-Akademie
Gildemeisterstraße 60 · D-33689 Bielefeld
Tel.: +49 (0) 52 05 / 74 - 25 01
Fax: +49 (0) 52 05 / 74 - 25 02

DMG Gebrauchtmachines
Lautitzer Straße 7 · D-82538 Geretsried
Tel.: +49 (0) 81 71 / 81 7 - 826
Fax: +49 (0) 81 71 / 81 7 - 878

Bielefeld
Gildemeisterstraße 60 · D-33689 Bielefeld
Tel.: +49 (0) 52 05 / 74 - 38 92
Fax: +49 (0) 52 05 / 74 - 38 91

Europe

DMG Austria
Oberes Ried 11 · A-6833 Klaus
Tel.: +43 (0) 55 23 / 6 91 41 - 0
Fax: +43 (0) 55 23 / 6 91 41 - 100

DMG Benelux
- **Niederland**
Wagenijsselaan 48 · NL-3903 LA Veenendaal
Tel.: +31 (0) 318 - 55 76 11
Fax: +31 (0) 318 - 52 44 29
Service Turning: +31 (0) 318 - 55 76 - 24
Service Milling: +31 (0) 318 - 55 76 - 33 / - 34
Service Fax: +31 (0) 318 - 55 76 - 10

- **Belgium**
Hermesstraat 4B · B-1930 Zaventem
Tel.: +32 (0) 2 / 7 12 10 - 90
Fax: +32 (0) 2 / 7 12 10 - 99
Service: +32 (0) 2 / 7 12 10 - 94

DMG Czech
Kaštanová 8 · CZ-620 00 Brno
Tel.: +420 545 426 311
Fax: +420 545 426 310
Service: +420 545 426 320
Service Fax: +420 545 426 325

DMG France
4 avenue du Parana, BP 60
F-91942 Courtaboeuf Cedex
Tel.: +33 (0) 1 / 69 18 60 00
Fax: +33 (0) 1 / 69 28 75 50
Service Fax: +33 (0) 1 / 69 28 55 73

- **Lyon**
ZI de Chesnes Le Loup · 13 rue du Moreillon
F-38070 Saint Quentin Fallavier
Tel.: +33 (0) 4 / 74 94 53 82
Fax: +33 (0) 4 / 74 94 51 52

- **Haute Savoie**
Espace Scionzier · 520 avenue des Lacs
F-74950 Scionzier
Tel.: +33 (0) 4 / 50 96 41 62
Fax: +33 (0) 4 / 50 96 41 30

DMG Hungary Kft
Bartfai u. 54 · H-1119 Budapest
Tel.: +36 1 430 1614
Fax: +36 1 430 1615

DMG Iberica Barcelona
Pol. Ind. Els Pinetons · Avenida Torre Mateu 2-8
Nave 1 · E-08291 Ripollet · Barcelona
Tel.: +34 / 93 - 5 86 30 86
Fax: +34 / 93 - 5 86 30 91

DMG Iberica S.L
Pol. Ind. Olaso Pab. 46
E-20870 Elgoibar · Guipúzcoa
Tel.: +34 94 374 03 50
Fax: +34 94 374 38 62

DMG Italia Bergamo
Via G. Donizetti 138
I-24030 Brembate di Sopra (BG)
Tel.: +39 035 62 28 201
Fax: +39 035 62 28 210
Service Hotline: +39 199 177 811
Service Fax: +39 035 6228 250

DMG Italia Tortona
Via W. Graziano 15
I-15057 Tortona (AL)
Tel.: +39 0131 81 81 61
Fax: +39 0131 81 81 65
Service Hotline: +39 199 177 811
Service Fax: +39 035 6228 250

DMG Italia Ancona
Via dell'Artigianato 36/38
I-60019 Senigallia (AN)
Tel.: +39 071 792 88 83
Fax: +39 071 792 95 92
Service Hotline: +39 199 177 811
Service Fax: +39 035 6228 250

DMG Polska
ul. Fabryczna 7 · PL-63-300 Pleszew
Tel.: +48 (0) 62 / 7428 151
Fax: +48 (0) 62 / 7428 114
Service: +48 (0) 62 / 7428 153

DMG Romania
Str. Prof. Stefan Chicos, nr. 1
Aleea Gladiolilor nr. 5
RO-110000 Ploesti · Arges
Tel.: +40 724 26 79 15
Fax: +40 248 27 10 48

DMG Russland
Nowoholowskaja-Strasse 23/1
RU-109052 Moskau
Tel.: +7 495 225 49 60
Fax: +7 495 225 49 61

DMG Scandinavia
- **Danmark**
Gammelgårdsvej 87 B th · DK-3520 Farum
Tel.: +45 49 12 74 10
Fax: +45 49 17 77 00
Service: +45 49 12 74 19
Service Fax: +45 49 17 78 00

- **Sverige**
Sjövagnsvägen 8 · S-192 55 Sollentuna
Tel.: +46 850 38 38 00
Fax: +46 850 38 38 90

- **Norge A/S**
Bjørkehagevegen 19 d · N-1405 Langhus
Tel.: +47 63 01 00 20
Fax: +47 63 01 00 21

DMG Schweiz
Lagerstrasse 14 · CH-8600 Dübendorf
Tel.: +41 (0) 44 / 8 24 48 - 48
Fax: +41 (0) 44 / 8 24 48 - 24
Service: +41 (0) 44 / 8 24 48 - 12
Service Fax: +41 (0) 44 / 8 24 48 - 25

DMG South East Europe E.P.E.
Emporia Ergalimihanon
9 km. National Road Thessaloniki-Maudanion
P.O. Box: 20596 · GR-55104 Thessaloniki
Tel.: +30 2310 47 44 86 · Fax: +30 2310 47 44 87

DMG Turkey
E-5 Uzeri, Küçükyalı Yanyol - Irmak Sokak
Küçükyalı İş Merkezi · E Blok No: 5
TR-34852 Maltepe · Istanbul
Tel.: +90-216-489 75 76
Fax: +90-216-489 18 09

DMG UK
Unitool House, 151 Camford Way
Sundon Park · GB Luton LU3 3AN
Tel.: +44 (0) 15 82 - 57 06 61
Fax: +44 (0) 15 82 - 59 37 00
Service Fax: +44 (0) 15 82 - 44 55 38

DMG Gebrauchtmachines CZ s.r.o.
Areal ZD Zálesi · CZ-763 41 Biskupice u Luhačovic
Tel.: +420 577 / 136 268
Fax: +420 577 / 136 273

Asia

DMG Asia Pacific Pte Ltd.
3 Tuas Link 1 · Singapore 638584
Tel.: +65 66 60 66 88 · Fax: +65 66 60 66 99
Service Hotline: +65 66 60 66 66
Service Fax: +65 66 60 66 67

DMG Asia Pacific Representative Office
72 Belvedere Street · Merville Park Subdivision
Brgy. Merville · Paranaque City · Philippines 1700
Tel.: +63 2 828 6172
Fax: +63 2 824 9600

DMG Asia Pacific Representative Office
Jl. Tampak Sirang X / No. 11 · RT01 / RW13
Bukit Sentul · 16810 Bogor · Indonesia
Tel.: +62 212 946 98 60
Fax: +62 21 8796 03 83

DMG Vietnam Representative Office
Unit #302, Blue Star Building · 93 Linh Lang Str.
Ba Dinh District · Hanoi · Vietnam
Tel.: +84 4 7665 924, +84 4 7665 925
Fax: +84 4 7665 926

DMG (Thailand) Co., Ltd.
315 Bangrak Trud Road · Kwaeng Bangna
Khet Bangna · Bangkok 10260 · Thailand
Tel.: +662 396 13 15
Fax: +662 396 13 16

DMG (Malaysia) Sdn Bhd
No. 57 Jalan Pentadbir UI/30 · Seksyen U1
Hicom-Glenmarie Industrial Park
40150 Shah Alam · Selangor · Malaysia
Tel.: +603 55 69 52 82
Fax: +603 55 69 52 86

DMG Machinery Taiwan Ltd.
No. 12-3, Industrial 33rd Road · Industrial Park
Taichung City, 407 · Taiwan R.O.C.
Tel.: +886 4 23 55 - 64 90
Fax: +886 4 23 55 - 65 05
Service Hotline: +886 4 23 55 - 64 90 ext. 115

DMG India
- **Bangalore**
Al-Latheef II · No. 2/1 Union Street,
Off Infantry Road · Bangalore 560 001 · India
Tel.: +91 80 41 13 12 81
Fax: +91 80 41 13 12 85
Service Hotline: +91 80 41 13 12 83

- **New Delhi**
407 · Ansals Majestic Tower · Vikasputri
New Delhi 110018 · India
Tel.: +91 11 415 867 61
Fax: +91 11 415 867 60

DMG China
178 Yin Du Road (West)
Shanghai 201612 · P.R. China
Tel.: +86 21 6764 8876
Fax: +86 21 6764 9033
Service Hotline: 800 820 0969

- **DMG Shanghai (Branch Office)**
178 Yin Du Road (West)
Shanghai 201612 · P.R. China
Tel.: +86 21 6764 8876
Fax: +86 21 6764 9827

- **DMG Beijing (Branch Office)**
Room 1605 · Tower B
Beijing Global Trade Center
No. 36 North Third Ring Road East
Dongcheng District
Beijing 100013 · P.R. China
Tel.: +86 10 5825 6006
Fax: +86 10 5825 6007

- **DMG Xi'an (Branch Office)**
Room 609 · Block C
Zhicheng Business
No. 17 Gaoxin 4th Road · Shaanxi Province
Xi'an 710075 · P.R. China
Tel.: +86 29 8833 5706
Fax: +86 29 8833 5705

- **DMG Chongqing (Branch Office)**
No. 35 · Yu Zhou Road
Shi Qiao Pu
Chongqing 400039 · P.R. China
Tel.: +86 23 6888 0145
Fax: +86 23 6888 0146

- **DMG Shenyang (Branch Office)**
Room 2017 · Rang Fu Plaza
No. 17 · Bei Er Dong Lu · Tie Xi District
Shenyang 110025 · P.R. China
Tel.: +86 24 2511 4263, +86 24 2511 2648
Fax: +86 24 2511 4253

- **DMG Guangdong (Branch Office)**
1st Floor · Juhe International Machine
Mould Metal Town
Jinxia Yilong Rd. · Changan Town
Dongguan City
Guangdong 523852 · P.R. China
Tel.: +86 769 8188 5988
Fax: +86 769 8188 5981
Service Fax: +86 769 8188 5982

DMG Korea Co., Ltd.
Seoul
Suite 606 · Daeryung Techno Town 6-cha
493-6, Gasan-dong
Geumcheon-gu · Seoul · Korea · 153-774
Tel.: +82 2 2113 9300
Fax: +82 2 2113 9333
Service Hotline: +82 80 67 74 751

DMG Nippon K.K.
Yokohama
2-15-1, Fukuura · Kanazawa-Ku
Yokohama 236-0004 · Japan
Tel.: +81 45 7 91 - 34 00
Fax: +81 45 7 91 - 34 01
Service Hotline: +81 45 7 91 - 34 80

DMG Australia Pty Ltd.
Unit 3, 25 Howleys Road
Notting Hill · Victoria 3168 · Australia
Tel.: +61 3 85 404 600
Fax: +61 3 85 404 601
Service Hotline: +61 3 85 404 606

DMG Training Academy Asia
Located at DMG Asia Pacific Pte Ltd.
3 Tuas Link 1
Singapore 628754
Tel.: +65 66 60 66 45
Fax: +65 66 60 66 99

DMG Training Academy Asia
Located at DMG Technology Trading
(Shanghai) Co., Ltd.
178 Yin Du Road (West)
201612 Shanghai · P.R. China
Tel.: +86 21 6764 88 76
Fax: +86 21 6764 94 47

DMG Used Machine Division
3 Tuas Link 1
Singapore 628754
Tel.: +65 66 60 66 63
Fax: +65 66 60 66 99

America

DMG Chicago Inc.
265 Spring Lake Drive
Itasca, IL 60143 · USA
Tel.: +1 (630) 227 - 3900
Fax: +1 (630) 227 - 3975
Service Fax: +1 (630) 227 - 3978

DMG Boston Inc.
20 Mall Rd., Suite 440
Burlington, MA 01803 · USA
Tel.: +1 (781) 229 - 0044
Fax: +1 (781) 229 - 0014

DMG Charlotte Inc.
13509 South Point Blvd.
Charlotte, NC 28273 · USA
Tel.: +1 (704) 583 - 1193
Fax: +1 (704) 583 - 1149
Service Fax: +1 (704) 583 - 1466

DMG Houston Inc.
16511 Hedgecroft, Suite 212
Houston, TX 77060 · USA
Tel.: +1 (281) 999 - 3641
Fax: +1 (281) 934 - 8443

DMG Los Angeles Inc.
5552 Cerritos Ave., Suite F
Cypress, CA 90630 · USA
Tel.: +1 (714) 527 - 4981
Fax: +1 (714) 527 - 4986

DMG Canada Inc.
165 Admiral Blvd.
Mississauga, ON L5T 2T3 · Canada
Tel.: +1 (905) 795 - 2891
Fax: +1 (905) 795 - 0393

DMG México S.A. de C.V.
Boulevard Diaz Ordaz No. 124
Colonia Santa María ·
Monterrey - Nuevo León 64650
México
Tel.: (+52) 81 / 8378 - 2900
Fax: (+52) 81 / 8378 - 6652

DMG Brazil
Rua Dr. Luiz Migliano - 173
05711-000 São Paulo - Brazil
Tel.: (+55) 11 / 3742 - 5000
Fax: (+55) 11 / 3773 - 8855